

## Sechskant- gewindeschrauben

## Hexagonal lock screws

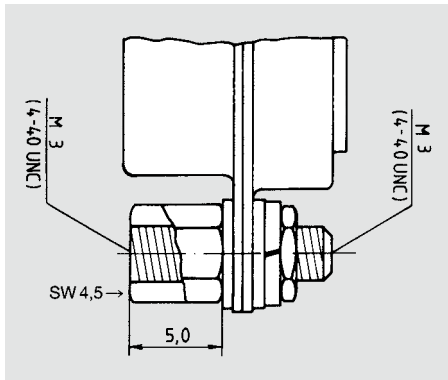

Bestellschlüssel / Model key

53 10 44 T A 002

Beispiel / example

Länge: s. Tabelle / Length: see table  
 Gewinde: s. Tabelle / Thread: see table  
 Oberfläche: T = verzinkt  
 Finish: T = tin plated  
 Zubehör: A = 1 Schraube, 1 Mutter, 1-Federring,  
 2 Distanzscheiben; 0 = Nur  
 Schraube, ohne Zubehör  
 Fittings: A = 1 screw, 1 nut, 1 spring washer,  
 2 distance screw; 0 = only screw, without  
 fittings  
 Verpackung: 002 = 2 Schrauben, 000 = lose  
 Package: 002 = screw in PVC bag,  
 000 = loosely packed

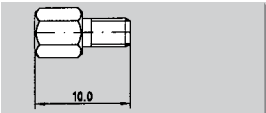
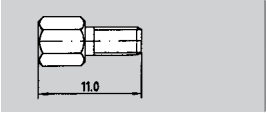
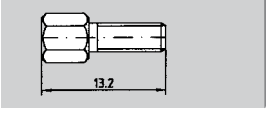
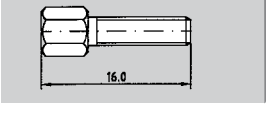
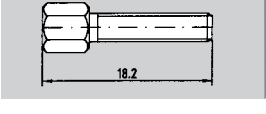
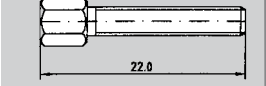
	UNC	M 3	Innen UNC / Internal UNC Außen M 3 / External M 3	Innen M 3 / Internal M 3 Außen UNC/ External UNC
	531044	531033	531043	531034
	531144	531133	531143	531134
	531344	531333	531343	531334
	531644	531633	531643	531634
	531844	531833	531843	531834
	532244	532233	532243	532234

## Sechskantgewindeschrauben

## Hexagonal screws

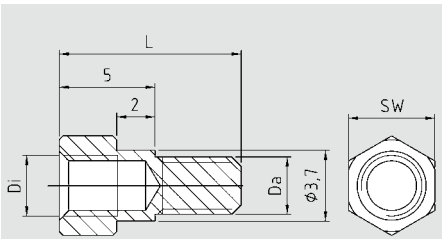

### Sechskantgewindeschrauben für Gehäusemontage Hexagonal screw for assembly with housing

Art. Nr. Art. No.	Abmessungen, mm Dimensions, mm			
	SW	L	Di	Da
5385S43T	4,5	8,5	4-40 UNC	M3
5395S33T	4,5	9,5	M3	M3
5395S34T	4,5	9,5	M3	4-40 UNC
5395S43T	4,5	9,5	4-40 UNC	M3
5395S44T	4,5	9,5	4-40 UNC	4-40 UNC
5311S44T	4,5	11,0	4-40 UNC	4-40 UNC
5313S33T	4,5	13,2	M3	M3
5313S34T	4,5	13,2	M3	4-40 UNC
5313S43T	4,5	13,2	4-40 UNC	M3
5313S44T	4,5	13,2	4-40 UNC	4-40 UNC
5395S533T	5,0	9,5	M3	M3
5395S543T	5,0	9,5	4-40 UNC	M3

Ein Satz vertütet: 5313 S44T A002  
Einzelteile lose (100 Stück): 5313 S44T A000

One set in PVC bag: 5313 S44T A002  
Single parts (100/bag): 5313 S44T A000

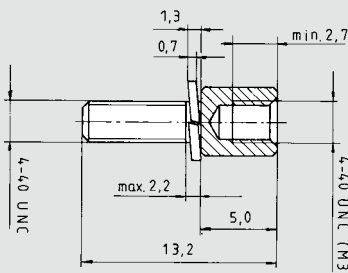

### Sechskantgewindeschraube mit unverlierbar aufgezogenem Federring Hexagonal screw with mounted spring washer

UNC 4-40  
Art.Nr. 531344FT

UNC 4-40  
Part No. 531344FT

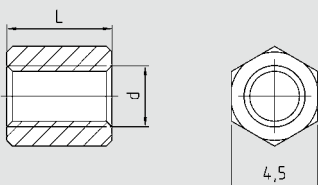

### Sechskantgewindebolzen verzinkt UNC 4-40-Gewinde Hexagonal threaded sleeve tin-plated UNC 4-40 thread

Art. Nr. Art. No.	d	L
535544T	4-40 UNC	5,5
535533T	M3	5,5
5310544T	4-40 UNC	10,5