











D-Sub-Kunststoffhauben/ Plastic Hoods	Gehäusegröße Hood size	Gehäuseversion/ Hood version		Verriegelungsart/Locking style				Kabelausgang/ Cable exit		Kabelanschluss/ Cable fixing				
		Serie Series	D-Sub Polzahl/ Pin number	Kunststoff/ Plastics Schwarz/ Black:s Metallisiert/ Metallized:m	Kunststoff/Plastic farbig/ coloured	Push-Pull-Quick-Lock	Rändelschrauben/ Knurled screws	Slide lock	Clip	gerade/ straight	gewinkelt (seitlich)/ angled (side-ways)	Klemme/ clamp intern (al)	Klemme/ clamp extern (al)	Crimpflansch/ Crimp flange
<b>Standard D-Sub Hauben / Standard D-Sub hoods</b>														
	07	9-50	s/m					x	x	x	2x30°	x	x	x
	17	9-50	s/m	x						x	25-50p: 2x30°	x		
	37	9-37	s/m											
	47	9-50	s/m								1x40°	x		
	47155	15	S/m								1x20°	x		
	57	9-25	s/m							x		x		
	77	9-37	s/m							x	9p-37p:2 x 90°	x		
	103	9-50	s/m					x		x	9p: 1x 15°/15p: 1x30°/ 25p-50p 2x30°	x	x	x
	104	9-50	s/m					x		x	9p: 1x 15°/15p: 1x30°/ 25p-50p 2x30°	x	x	x
<b>Adapter D-Sub Hauben / Adapter D-Sub hoods</b>														
	67	9/9- 9/25, 15/15, 25/25	s/m	x										
	77	9-37	s/m											
	87	9-25	s/m											
<b>Wassergeschützte Hauben / Water resistant hoods</b>														
	97 (IP67)	9-25	s							x				

D-Sub-/DVI-Metallhauben/ Diecast Hoods	Hauben-Serie Hood series	Gehäusegrösse Hood size	Verriegelungsart/Locking style				Kabelausgang/Cable exit		Kabelanschluss/Cable fixing	
			Push-Pull-Quick-Lock	Rändelschrauben/ Knurled screws	Slide lock	Clip	gerade/ straight 180° 9p-50p	gewinkelt/ angled	Kabelklemme/ Cable clamp intern(al)/ extern(al)	Crimpflansch/ Crimp flange
<b>Standard D-Sub Hauben/Hoods</b>										
	07DC	9, 15, 25, 37, 50			x	x	x	2x30°		x
	17DC	9, 15, 25, 37, 50		x			x	25-50p: 2x30°	i	
	47DC	9, 15, 25		x				1x40°		x
	77DC	9, 15								
	Axial Compact Special	9		x				2x75° (parallel)		
	104DC	9, 15, 25, 37, 50	x				x	9p: 1x 15°/15p: 1x30°/25p- 50p2x30°	i/e	x
	117DC 147DC	9, 15, 25, 37, 50		x			x	9-15: 1 x 180° oder /or 1 x 45° 25-50: 1 x 180° oder /or 2 x 45°	i/e	x
	118DC	15		x			x	1x90°	i/e	x
<b>Economy D-Sub Hauben/Hoods</b>										
	109DC	9, 15, 25, 37		x			x		i	
	110DC	9, 15, 25, 37		x				1x45°	i	
<b>DVI Hauben/Hoods</b>										
	119DC 128DC	15		x			x		i/e	x

**Lange Vollmetallhaube  
Rändelschrauben  
Kabelausgang 180° und 90°**

**Long die cast hood  
Knurled screws  
Cable output 180° and 90°**

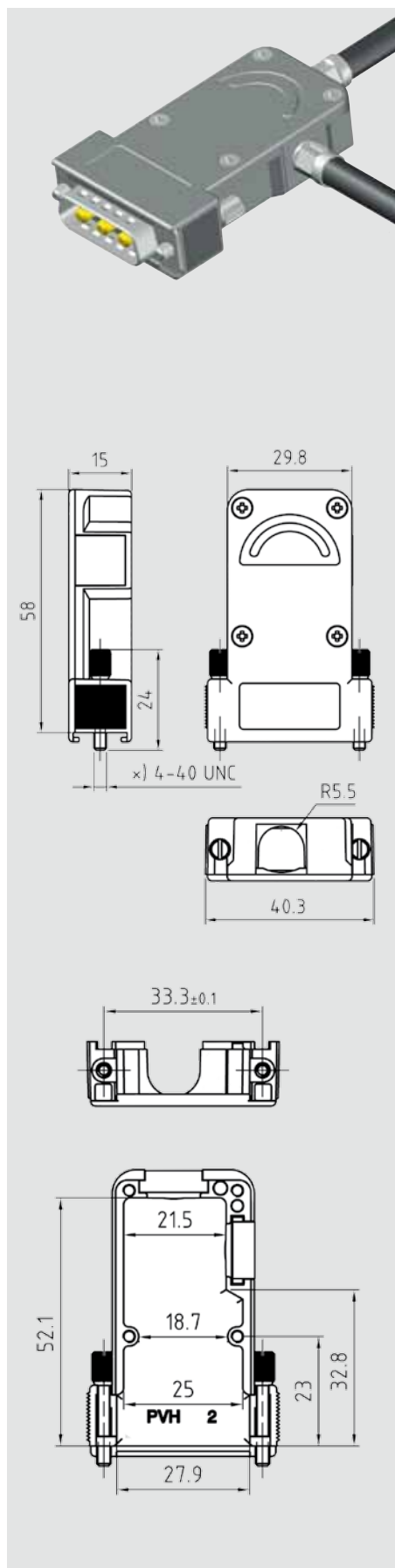

**Technische Merkmale**

- Großer Einbauraum für
  - große Kabeldurchmesser
  - Mischpol D-Sub
  - EMV-Elektronikgehäuse (Kabelausgänge verschlossen mit 2 Blindkappen)
- 3 Kabelzugentlastungsversionen
  - interne Kabelklemme
  - externe Kabelklemme
  - Crimpflansch
- einfache Montage durch wenig Einzelteile und vormontierte Rändelschrauben
- 2 Kabelausgänge

**Technical Features**

- Extended installation space for
  - big cable diameter
  - mixed layout D-Sub
  - EMC electronic housing (cable outputs closed with 2 blind plates)
- 3 cable strain relief versions
  - internal cable clamp
  - external cable clamp
  - crimp flange
- simple assembly by only a few single parts and pre-assembled locking screws
- 2 cable outputs

Technische Daten / Technical data	
<b>Kabeldurchmesser / cable diameter</b>	
interne Kabelklemme / internal cable clamp	4 – 12 mm
externe Kabelklemme / external cable clamp	4 – 14 mm
Crimpflansch / crimp flange	3,7-8,7 mm
<b>Temperaturbereich / Temperature range</b>	-25 °C – +85 °C

**Bestell-Informationen/Ordering information**

Hauben als Set vertütet/ Hoods as a set in plastic bag

Beschreibung/Description	Gewinde/Thread	Bestell-Nr./Order no.
Crimpflansch/ Externe Kabelklemme Crimp flange/ external cable clamp	UNC4-40 M3	118090DC25001 118091DC25001
Interne Kabelklemme/ Internal cable clamp	UNC4-40 M3	118092DC25001 118093DC25001

Hauben als Einzelteile vertütet/Hoods as separate parts in plastic bag  
(Verpackungseinheit/ Packaging unit: 100 Stck/ pcs)

Beschreibung/Description	Gewinde/Thread	Bestell-Nr./Order no.
Crimpflansch/ Externe Kabelklemme Crimp flange/ external cable clamp	UNC4-40 M3	118090DC25000 118091DC25000
Interne Kabelklemme/ Internal cable clamp	UNC4-40 M3	118092DC25000 118093DC25000