

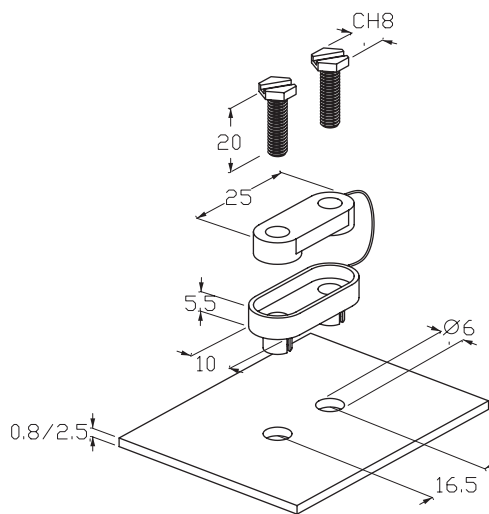

TH005 PATENTED

FISSACAVO AD AGGANCIO RAPIDO.
QUICK LOCKING CABLE CLAMP.

TH005



CE RoHS

Dimensioni in millimetri. *Dimensions shown in millimetres.*

Dati generali *General data*

Dati tecnici *Technical data*

Diametro cavo	max 10.0 mm	<i>Cable diameter</i>
Temperatura di funzionamento	-40°C to +125°C	<i>Operating temperature</i>
Prova di trazione cavo a 45°C	24 kg (240 N)	<i>Tensile test of the cable at 45°C</i>

Materie prime *Raw materials*

Corpo	PA66 UL94 V2 GWT 850°C naturale <i>natural</i>	<i>Body</i>
-------	---	-------------

Norme *Standards*

EN60598-1-2004+A1:2006

Eventuali modifiche e migliorie sui dati tecnici o sul prodotto potranno essere effettuate senza preavviso.
All technical data or other eventual product modifications and improvements can be carried out without notice.

TH005 PATENTED

FISSACAVO AD AGGANCIO RAPIDO. QUICK LOCKING CABLE CLAMP.

TH005

Codice Order number



versione version	pz/imb pcs/box	codice order number
	500	THA.005.001

Varianti Options

Colore Colour Contatta il Servizio Clienti per maggiori informazioni. *Contact our Customer Service for availability.*

versione version	codice order number
<input type="checkbox"/> altri colori <i>other colours</i>	THA.005.001.CX

Kit di fornitura Purchasing kit

versione version	misure imballaggio box dimensions	contenuto contents	pz/imb pcs/box	codice order number
kit standard <i>standard kit</i>	C01 (320X210X120 mm)		500	THA.005.001
kit imbustato <i>retail pack kit</i> Consulta il catalogo Rivenditori. <i>See the Retailers catalogue.</i>	--		--	THA.005.001.R
versione speciale <i>custom version</i>	*	*	*	THA.005.001.K

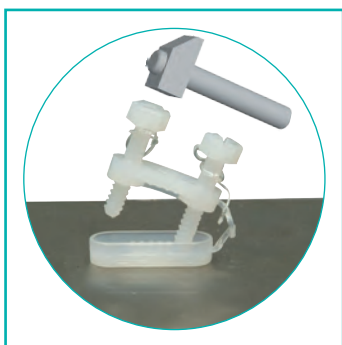

Esegui due fori: utilizza un martello per fissare il cavo e il fissacavo.
Make two holes: use a hammer to fix the cable and the cable clamp.

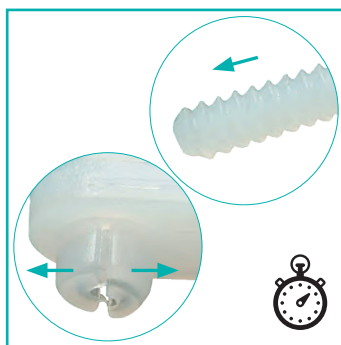

Fissaggio veloce: inserimento delle viti ad aggancio graduale. Alette di espansione garantiscono tenuta del cavo e del fissacavo sul supporto.
Quick installation: screws gradually enter the holes. The two fins expand so fixing the cable and the cable clamp onto a support.

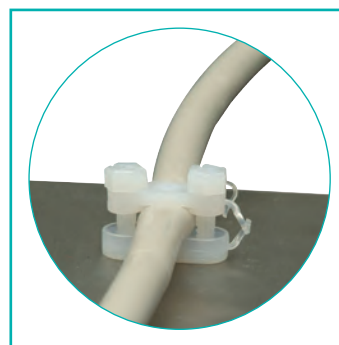

Fissaggio sicuro.
Safety fixing.

*** Sono possibili personalizzazioni di prodotto e progetti su richieste specifiche. Contatta il Servizio Clienti.**
Personalization and new custom products are possible. Please contact our Customer Service.

Eventuali modifiche e migliorie sui dati tecnici o sul prodotto potranno essere effettuate senza preavviso.
All technical data or other eventual product modifications and improvements can be carried out without notice.